

EKLC18

1800W

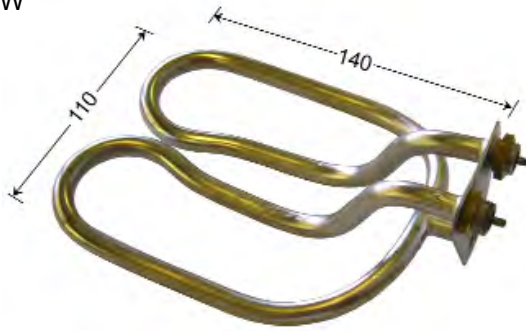

EKES24E

2400W



412 20

2000W



412 24

2400W

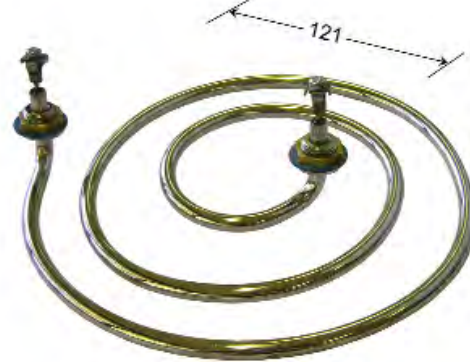

KT870000

2400W

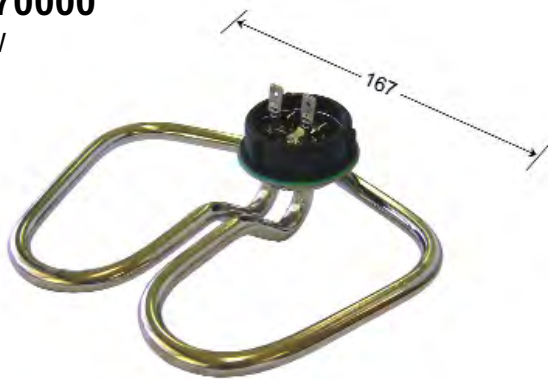

904

1200W

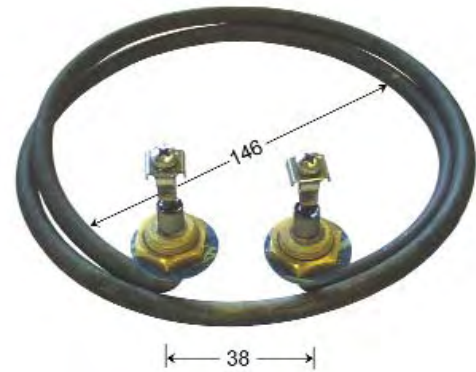

Nickel Alloy Tube

KT42A000

2400W

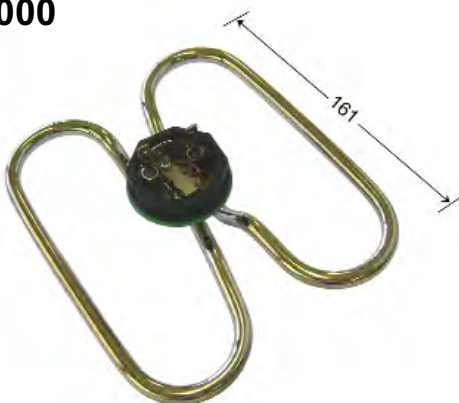

FUTURE LISTINGS



90994

2400W



Cafe Bar "Compact"

906

750W

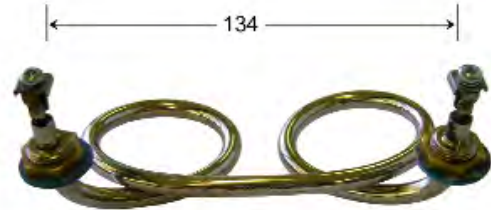

91317G2

2400W

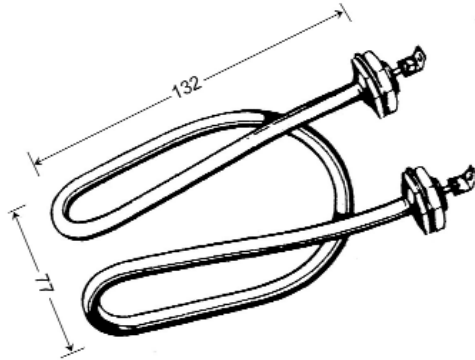

Cafe Bar

9565

2400W

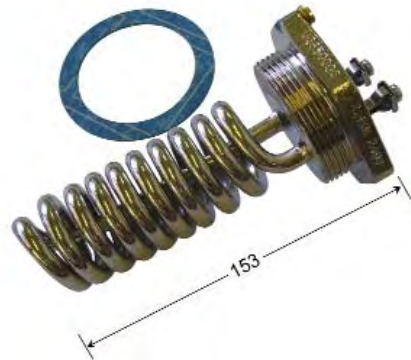

2" BSP
Coffee Dispenser

1310725

2400W

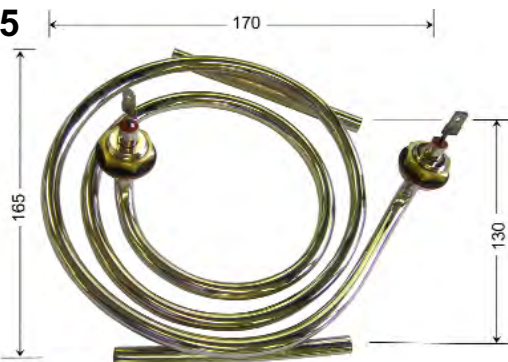

To Suit Birko Urns 10L, 20L
Uses standard 3/8" bush (no locating ridge)

4073315

3000W

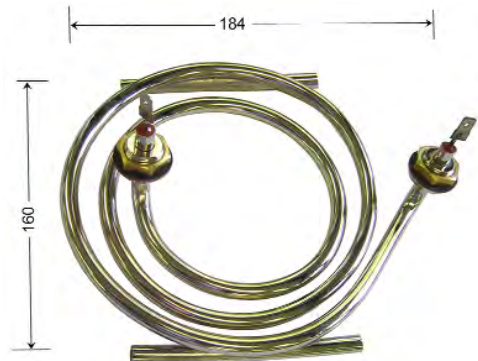

To Suit Birko Urns 10L, 20L
Uses standard 3/8" bush (no locating ridge)

91295

2200W



Cafe Bar
Nickel Alloy Tube

UZ95E000

2400W

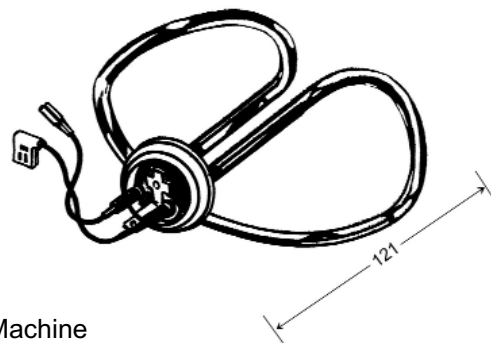

Coffee Machine
Nickel alloy tube

2158

2400W

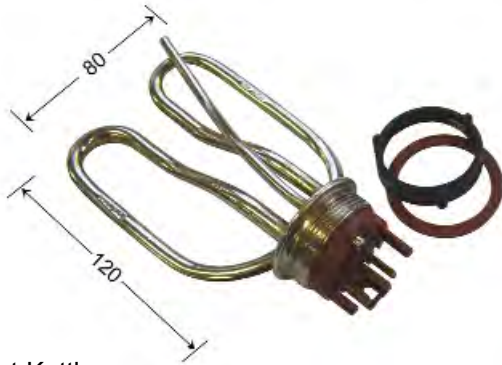

Element Kettle

FW530000

2400W

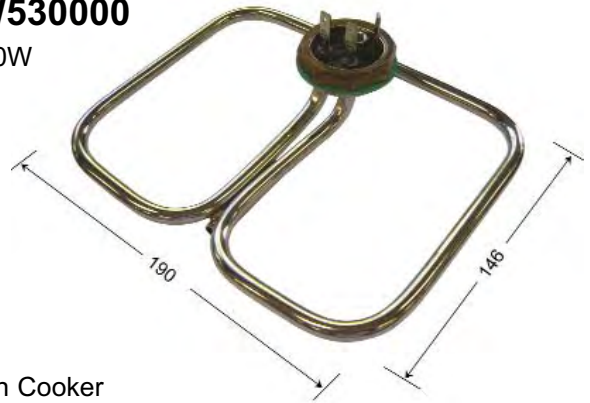

Corn Cooker

FUTURE LISTINGS

FUTURE LISTINGS

FUTURE LISTINGS

FUTURE LISTINGS

FUTURE LISTINGS

FUTURE LISTINGS

THERMOSTATS AND CONTROLS

EA5-501S

25 A
25-105 degrees C
860mm capillary
Nut / Spindle mounting



TYJ6333

15A
Simmerstat



NT-182S

16 A
30-110 degrees C
Screw mounting
1000mm capillary



55-18022-020

Urn Thermostat
30-120 degrees C



**COPPER ELEMENT
(NICKEL- PLATED)
2400W**



4108
With Hook

Designed for heating clean water.

**NICKEL ALLOY ELEMENT
2400W**



4108B
With Hook

For superior corrosion resistance and longer life.

**COPPER ELEMENT
(NICKEL- PLATED)
1500W**



4053
Portable Heater with Socket to
suit Australian Standard Plug



Socket view

Instruction Leaflet

4108 Immersion Heater Series

The **4108 Series** 240 volt, immersion heaters are designed to heat water in metal containers. The heater should be placed into liquid before being turned on and should be unplugged from the power supply before removing from liquid. The heater will have some residual heat for a short time after being turned off, so it should not be placed on combustible surfaces. Care should also be taken to avoid contact with the heating zone until the heater has cooled down. The heater is designed for use by responsible adults, so it should be kept out of reach of children or infirmed persons.

The power cord supplying the heater cannot be replaced and, if damaged, the complete appliance should be disabled and disposed of.

The measurements for minimum and maximum entry into liquid are in millimetres and measured from the bottom of the appliance. Operating outside these dimensions will result in unsafe use of the appliance. See illustration below.

WARNING. The heater is not designed to operate in open air. Operating the heater out of water will result in failure of the appliance.

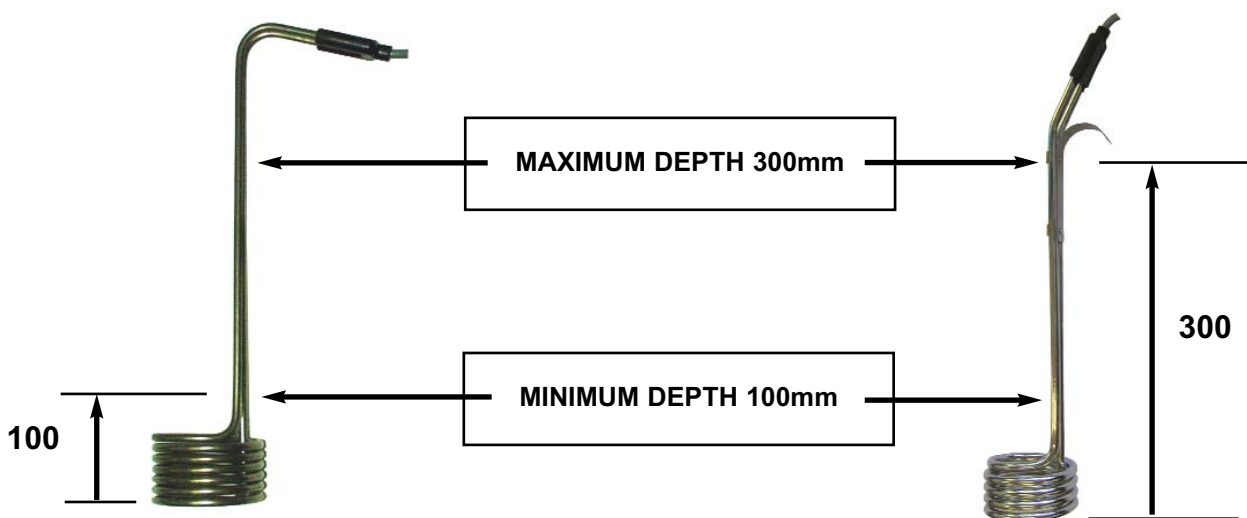

FEAT

6000W
1 1/4" SCREW IN IMMERSION ELEMENT



FIELD

8000W
1 1/4" SCREW IN IMMERSION ELEMENT

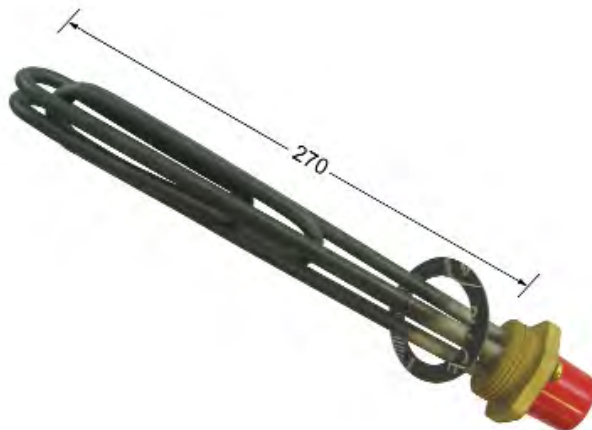

VN720004

1750W
SAUNA HEATER

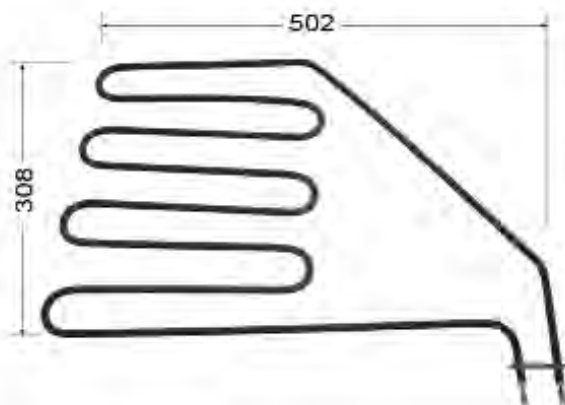

This page intentionally left blank – more new products coming soon

Check out the on line catalogue at www.grimwoodheating.com.au for the latest